

DC-DC CONVERTER AER50-W

RAILWAY CONVERTER.

FOR PCB MOUNTING



HIGHLIGHTS

- + Output Power up to 50 Watts
- + Efficiency up to 89 %
- + Ultra Wide Input Range
- + Wide Temperature Range
- + Remote On/Off
- + RoHS compliance
- + According to EN50155

INPUT

Input Voltage Nominal 24, 36, 48, 72, 96, 110 VDC

OUTPUT

Output Voltage 5, 12, 24 and 48 VDC

Initial Set Accuracy < 1 %*

Minimum Load No minimum load

Short Circuit Continuous short circuit proof

Line Regulation < 0,2 %, see note 1 page 3

Load Regulation < 0,2 %, see note 2 page 3

Ripple & Noise 40 mV RMS, 100mV pk-pk, 20 MHz bandwidth**

Start Time 30 ms typ.

Max. Output Capacitance See table page 2

Temperature Coefficient < 0.02 %/°C

FEATURES

Remote On/Off See notes 4 & 5 page 3

Sense +/- Remote sense to compensate for lead drops of the output line up to 10 %

Trim -20 %, +10 % adjustable output voltage (with an external resistor)

PROTECTION

Over Temperature Protection (OTP) Shut down at typ. 110°C baseplate temp. with about 15°C hysteresis and auto recovery

Over Voltage Protection (OVP) 115-140 % $V_{out, nom}$

Over Current Protection (OCP) 110-220 % $I_{out, nom}$

GENERAL

Product Standard EN 50155

Isolation Input to Output 3000 VDC

Input to case 2500 VDC

Output to case 500 VAC

Isolation Resistance > 100MΩ Input to Output

Isolation Capacitance typ. 1nF Input to Output

Switching Frequency Typ. 240 kHz

Lead Temperature 260°C (1,5 mm from case for 10 sec.)

Dimensions [mm] 57.9 x 36.8 x 12.7

Weight 61,5 g

MTBF 780.000h acc. to MIL-HDBK-217F (GB, 25°)

Fire & Smoke EN 45545-2

ENVIRONMENTAL

Operating Case Temp. -40°C to +100°C

Max. Operating Altitude 5000 m

Storage Temperature -55°C to +125°C

Vibration / Shock / Bump MIL-STD-810F / EN 61373:1999 Cat. 1B

EMC & SAFETY

EMC Standard EN 50121-3-2:2006, see note 7 page 3

Conducted Emissions EN 55011, Class A, with external input filter***

ESD Immunity EN 61000-4-2:2009 Air ± 8 kV, Contact ± 6 kV, Criteria A

Burst EN 61000-4-4:2012 ± 2 kV, Criteria A****

Surge EN 61000-4-5:2014 line to line ± 2 kV, Crit. A****

Line to earth ± 4 kV, Criteria A

Conducted Immunity EN 61000-4-6:2014 10 V, Criteria A

Radiated Immunity EN 61000-4-3:2006 20 V/m, Criteria A

Safety UL60950-1 2nd (basic insulation)

* For $T_{amb} = 25^{\circ}\text{C}$, $V_{in, nom}$, $I_{out, nom}$

** See note 3 page 3

*** In built-in condition our devices may show different EMC properties

**** With external capacitor and suppressor diode

TECHNICAL DATA

For $T_{amb}=25^{\circ}\text{C}$, $V_{in\ nom}$, $I_{out\ nom}$ unless otherwise specified.

SPECIFICATION Input 14 - 160 VDC**

TYPE	ORDER NUMBER	AER50-W			AER50-W			AER50-W			AER50-W			
		Min	Typ	Max	Min	Typ	Max	Min	Typ	Max	Min	Typ	Max	
CHARACTERISTIC	Unit													
INPUT	Input Voltage Operating	14...160												
	Max. Input Surge Voltage (100 ms max.)	200												
	Under Voltage Turn-on	13,2...14												
	Under Voltage Turn-off	11,8...12,6												
	Input Current @ Full Load 72 V		530			810			810			810		
	Input Current @ No Load (typical)	5			5			5			8			
	Standby Input Current (typical)	3												
OUTPUT	Output Voltage	5			12			24			48			
	Output Current			6			4,2			2,1			1,05	
	Output Power			30			50,4			50,4			50,4	
	Max. Capacitive Load			10000			6800			3300			680	
	Efficiency @ Full Load 72V		83			87			89			88		
	Efficiency @ Full Load 110V		81			86			87			85		
	Output Current Limit Inception*	%	110	180	220	110	180	220	110	180	220	110	180	220
	Transient Response 75% / 100% Load Step, Recovery Time <250 μs	%	$\pm 5\%$											

* Hiccup mode, auto recovery

SPECIFICATION Input 14 - 160 VDC - Negative Remote On/Off logic**

TYPE	ORDER NUMBER	AER50-W			AER50-W			AER50-W			AER50-W			
		Min	Typ	Max	Min	Typ	Max	Min	Typ	Max	Min	Typ	Max	
CHARACTERISTIC	Unit													
INPUT	Input Voltage Operating	14...160												
	Max. Input Surge Voltage (100 ms max.)	200												
	Under Voltage Turn-on	13,2...14												
	Under Voltage Turn-off	11,8...12,6												
	Input Current @ Full Load 72 V		530			810			810			810		
	Input Current @ No Load (typical)	5			5			5			8			
	Standby Input Current (typical)	3												
OUTPUT	Output Voltage	5			12			24			48			
	Output Current			6			4,2			2,1			1,05	
	Output Power			30			50,4			50,4			50,4	
	Max. Capacitive Load			10000			6800			3300			680	
	Efficiency @ Full Load 72V		83			87			89			88		
	Efficiency @ Full Load 110V		81			86			87			85		
	Output Current Limit Inception*	%	110	180	220	110	180	220	110	180	220	110	180	220
	Transient Response 75% / 100% Load Step, Recovery Time <250 μs	%	$\pm 5\%$											

* Hiccup mode, auto recovery

** All types also available without threaded hole

TECHNICAL DATA

For $T_{amb} = 25^{\circ}\text{C}$, $V_{in\ nom}$, $I_{out\ nom}$, unless otherwise specified.

MECHANICAL DETAILS

- Dimensions are in inches [mm].
- Tolerance: Inches: X.XX \pm 0.02, X.XXX \pm 0.010
Millimeters: X.X \pm 0.5, X.XX \pm 0.25

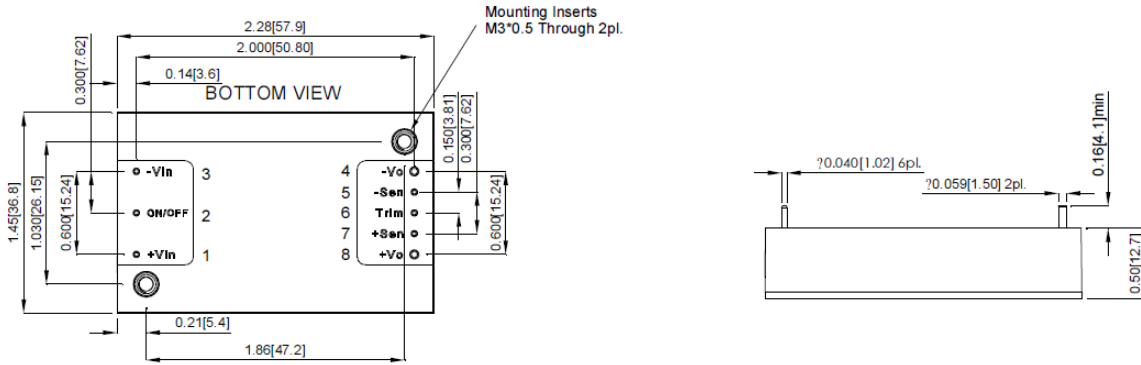

Case Material: Plastic, DAP
Baseplate Material: Aluminium
Potting Material: UL 94V-0
Pin Material: Base: Copper
Plating: Nickel with Matte Tin
Weight: 61.5 g

PINNING

Pin	Function
1	+V _{in}
2	Remote On/Off
3	-V _{in}
4	-V _{out}
5	-Sense
6	Trim
7	+Sense
8	+V _{out}

NOTES

- Measured from high line to low line.
- Measured from full load to zero load.
- Output ripple and noise measured with 22 μF aluminum solid capacitor and 1 μF ceramic capacitor across output.
- Logic compatibility

Module on	open collector ref to -Input
Module off	>3.5 VDC to 160 VDC or open circuit
	0 to <1.2 VDC
- For model number with negative logic remote on/off

Module on	0 to <1.2 VDC
Module off	>4.0 VDC to 160 VDC or open circuit
- For model with clear mounting insert (3.2 mm DIA.)
- For information about EN 50155 and RIA12, refer to application note.

Installation instructions:

The converters have to be installed according to the guidelines currently in force, like other open electronic component assemblies. Attention must be paid to sufficient ventilation, carry off heat, fastening and protection against accidental contact. Plug in not under voltage. The mounting surface must be flat and able to remove the thermal energy of the baseplate (baseplate temperature must not exceed +100°C). The baseplate has to be grounded by using thread rolling screws M3 according to DIN 7500.

Fault protection:

For input protection a time-lag fuse corresponding to IEC 60127-2 must be installed. For recommended rating of the fuse refer to application note section 7.1. Pay attention on sufficient current source in case of short circuit. In some applications 2 fuses would be necessary, one in each input line. An external input capacitor 68 μF for all models are recommended to reduce input ripple voltage.

BLOCK DIAGRAM

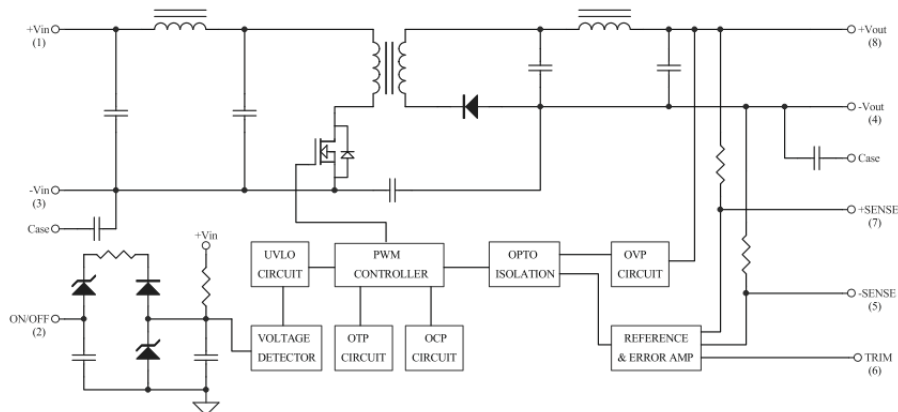

DESCRIPTION OF FEATURES

REMOTE ON/OFF

The AER50-W series allows the user to switch the module on and off electronically with the remote on/off feature. All models are available in "positive logic" and "negative logic" (optional) versions. The converter turns on if the remote on/off pin is high (>3.5Vdc to 160Vdc or open circuit). Setting the pin low (0 to <1.2Vdc) will turn the converter off. The signal level of the remote on/off input is defined with respect to ground. If not using the remote on/off pin, leave the pin open (converter will be on). Models with part number suffix "N" are the "negative logic" remote on/off version. The unit turns off if the remote on/off pin is high (>4.0Vdc to 160Vdc or open circuit). The converter turns on if the on/off pin input is low (0 to <1.2Vdc). Note that the converter is off by default.

Logic State (Pin 2)	Negative Logic	Positive Logic
Logic Low – Switch Closed	Module on	Module off
Logic High – Switch Open	Module off	Module on

The converter remote On/Off circuit built-in on input side. The ground pin of input side Remote On/Off circuit is -Vin pin. Connection examples see below.

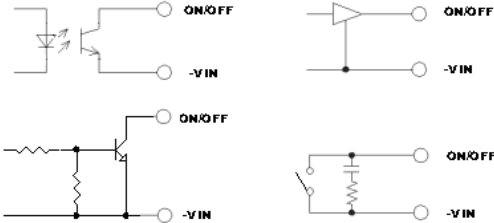

OUTPUT REMOTE SENSING

The AER50-W series converter has the capability to remotely sense both lines of its output. This feature moves the effective output voltage regulation point from the output of the unit to the point of connection of the remote sense pins. This feature automatically adjusts the real output voltage of the AER50-W series in order to compensate for voltage drops in distribution and maintain a regulated voltage at the point of load. The remote-sense voltage range is:

$$[(+V_{out}) - (-V_{out})] - [(+Sense) - (-Sense)] \leq 10\% \text{ of } V_{o_nominal}$$

When remote sense is in use, the sense should be connected by twisted-pair wire or shield wire. If the sensing patterns short, heavy current flows and the pattern may be damaged. Output voltage might become unstable because of impedance of wiring and load condition when length of wire is exceeding 400mm. This is shown in the schematic below.

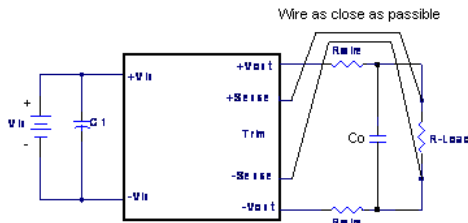

If the remote sense feature is not to be used, the sense pins should be connected locally. The +Sense pin should be connected to the +Vout pin at the module and the -Sense pin should be connected to the -Vout pin at the module. Wire between +Sense and +Vout and between -Sense and -Vout as short as possible. Loop wiring should be avoided. The converter might become unstable by noise coming from poor wiring. This is shown in the schematic below.

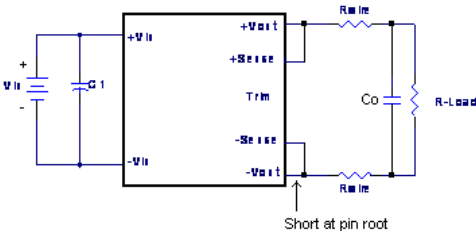

OUTPUT TRIMMING

Output may be externally trimmed (-20% to +10%) with a fixed resistor or an external trim pot as shown (optional). Model specific formulas for calculating trim resistors are available upon request as a separate document.

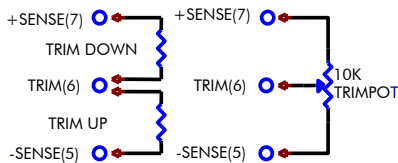

In order to trim the voltage up or down, one needs to connect the trim resistor either between the trim pin and -Sense for trim-up or between trim pin and +Sense for trim-down. The output voltage trim range is -20% to +10%. This is shown:

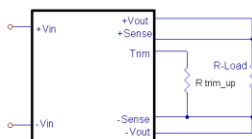

Trim-up Voltage Setup

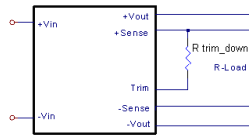

Trim-down Voltage Setup

EMC CONSIDERATIONS

EMI Test standard: EN 50121-3-2 Conducted & Radiated Emission
 Test Condition: Input Voltage: 110Vdc, Output Load: Full Load

(1) EMI meet EN 55011 / EN 55022 / EN 50121-3-2:2006

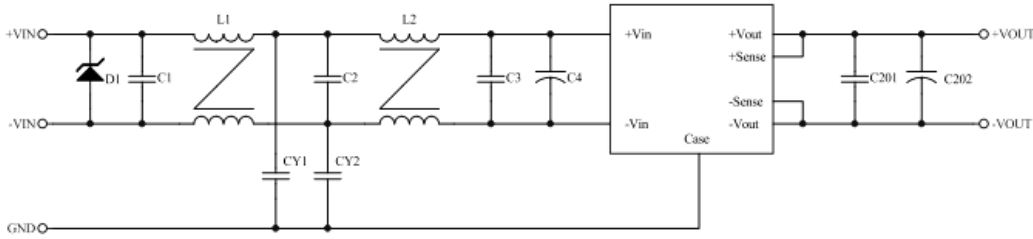

C1,C2,C3	C4	C201	C202	CY1,CY2	D1	L1,L2
1µF/250V 1812 Ceramic Cap.	82µF/250V KXJ Series Aluminum Cap.	1µF/100V 1206 Ceramic Cap.	22µF/100V Solid Aluminum Cap.	1500pF	1.5KE180A	URT24-050055H 5.5mH

Note: C4 UNITED CHEMI-CON KXJ series or equivalent, CY1, CY2 MURATA Y1 capacitors or equivalent, L1, L2 BULL WILL URT24-05055H or equivalent

SERIES OPERATION

Series operation is possible by connecting the outputs two or more units. Connection is shown in below. The output current in series connection should be lower than the lowest rate current in each power module.

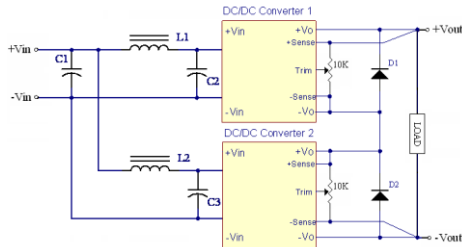

Simple Series Operation Connect Circuit
 L1, L2: 1.0µH
 C1, C2, C3: 68µF/200V ESR<0.7Ω

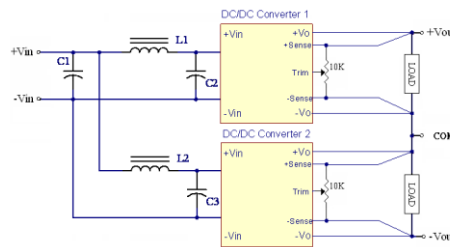

Simple ±Output Operation Connect Circuit
 L1, L2: 1.0µH
 C1, C2, C3: 68µF/200V ESR<0.7Ω

PARALLEL AND REDUNDANT OPERATION

The AER50-W series parallel operation is not possible. Parallel for redundancy operation is possible by connecting the units as shown in the schematic below. The current of each converter become unbalance by a slight difference of the output voltage. Make sure that the output voltage of units of equal value and the output current from each power supply does not exceed the rate current. Suggest use an external potentiometer to adjust output voltage from each power supply.

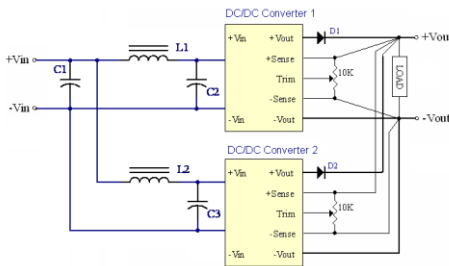

Simple Redundant Operation Connect Circuit
 L1, L2: 1.0µH
 C1, C2, C3: 68µF/200V ESR<0.7Ω

INPUT FUSING AND SAFETY CONSIDERATIONS

The AER50-W series converters have no internal fuse. In order to achieve maximum safety and system protection, always use an input line fuse. We recommended a 6A fast acting fuse for all models. It is recommended that the circuit have a transient voltage suppressor diode (TVS) across the input terminal to protect the unit against surge or spike voltage and input reverse voltage (as shown).

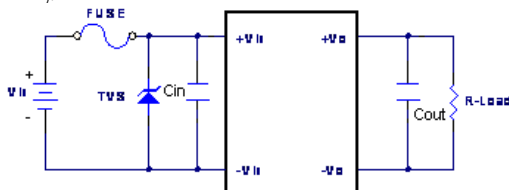

The external TVS is required if AER50-W series has to meet EN 61000-4-4, EN61000-4-5. The AER50-W series recommended a TVS (Littelfuse 1.5KE180A) to connect parallel.